

DRAWING (mm)

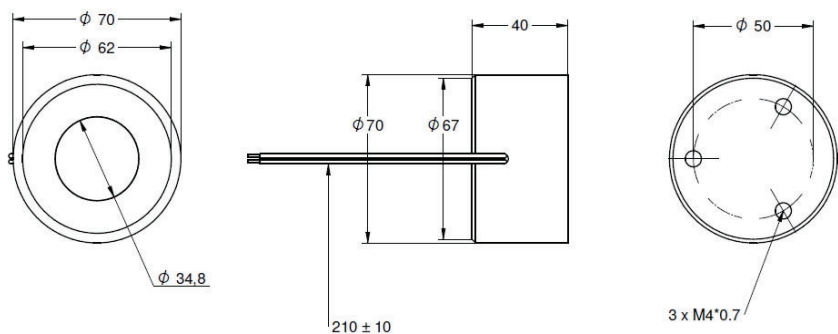

PHOTO



MODEL NO. DESIGNATION

EM7040 - VOLTAGE

Example: EM7040-12V

SOLENOID DATA

Voltage	12V or 24V
Holding force	approx. 1200N
Weight	800g
Nominal power	19W

ADDITIONAL DATA

Insulation grade	B
Dielectric withstand test	600V r.m.s.
Duty cycle	100%

SOLENOID FEATURES AND STANDARD DATA

	STANDARD	CUSTOMIZATION OPTIONS
Type	Electromagnet	
Cable	Flying wire 210mm	Length, type and connector
Voltage	12 or 24 VDC @ 100% ED	
Life time	500.000 single strokes	
Operating temperature	-20° ... +45°C	Up to +180°C
Manufacturing quality standards	ISO9001, IATF16949	
RoHS compliance	Yes	
CE approval	No	
UL approval	No	